

Frascold[®]

C6

Frascold open type reciprocating compressors
for refrigeration, air conditioning, cooling process and marine applications

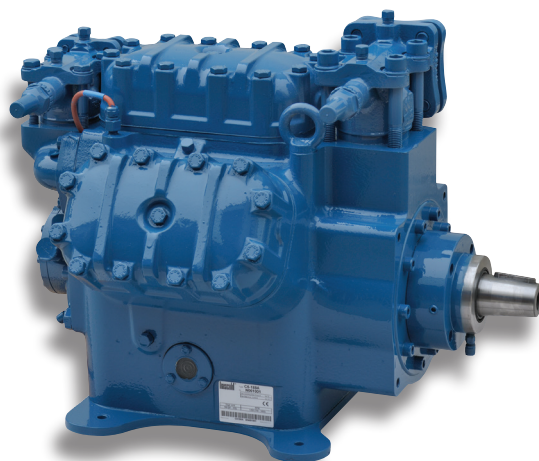

C6 SERIES

The new generation of Frascold C6 open drive reciprocating compressors has been designed with the utmost attention to compactness, reliability and flexibility. Two different series are offered: one is specifically designed for ammonia (R717), the second is suitable for operation with HFC and HCFC. At the moment the range consists of 6 models, all of them realised on a six cylinder frame. C6 compressor series is suitable for several applications: refrigeration, air conditioning, cooling process, marine and ATEX zone.

Main features

The new C6 compressors series is characterised by the following main features:

Compactness

Compact design and reduced overall dimensions ease of installation and maintenance.

Coupling

Direct coupling with an electric motor or through a belt drive.

Reliability

The robust 6 cylinders technology combined with a reliable shaft seal assures a long life time.

Flexibility

Two different series are available, one is optimized for ammonia (R717), the second is suitable for operation with both HFC and HCFC.

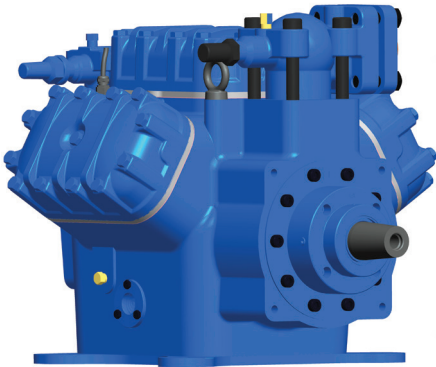

Model designation

Compressor

C 6 188 A

Family Series	
Open reciprocating compressor	
Number of Cylinders	
6	
Displacement	
146 to 188 m ³ /h at 50 Hz	
Application	
A	Suitable for R717 (NH ₃)
Y	Suitable for HFC and R22

Standard extent of delivery

The C6 series of compressors is supplied with suction and discharge valves, two oil level sight glasses, lubricant charge (POE 68 oil for HFC and HCFC; naphthenic mineral oil for R717), holding charge (nitrogen).

Optional accessories for HFC & HCFC

- Discharge temperature sensor
- Oil pressure switch
- Head fan motor
- Crankcase heater
- Capacity control head
- Unloaded start
- Water cooled head
- Coupling joint / pulley
- Oil level switch
- Oil level regulator
- FLI liquid injection device
- Elevated base plate

Optional accessories for ammonia (R717)

- Discharge temperature sensor
- Head fan motor
- Crankcase heater
- Water cooled head
- Coupling joint / pulley
- Elevated base plate

Operating limits

R404A

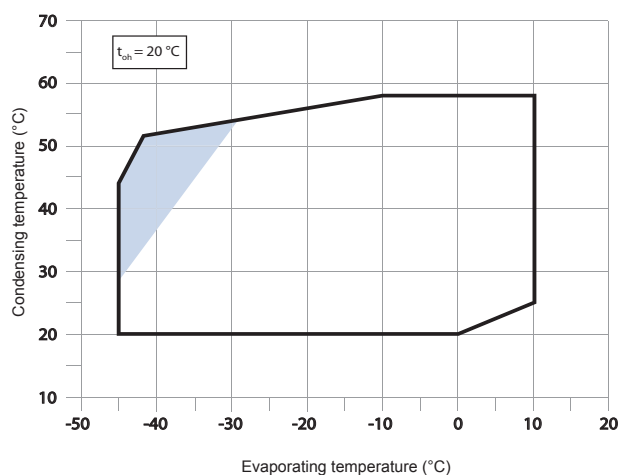

R134a

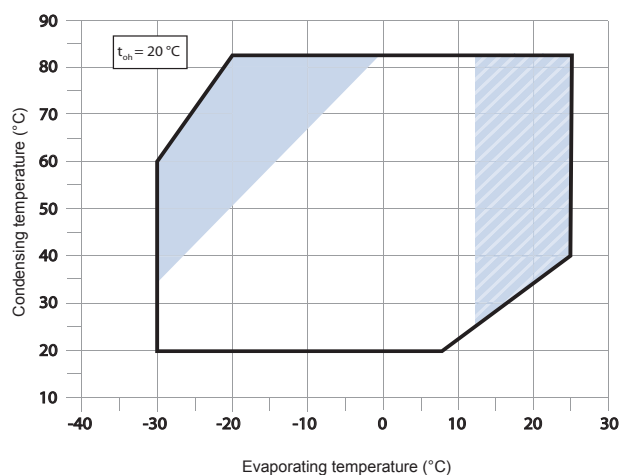

R22

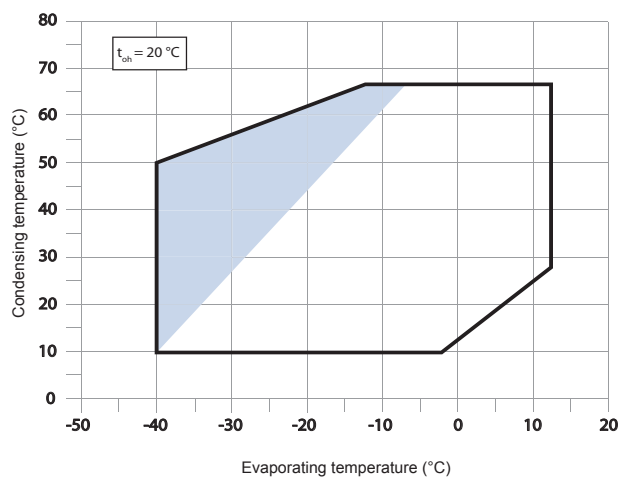

R717

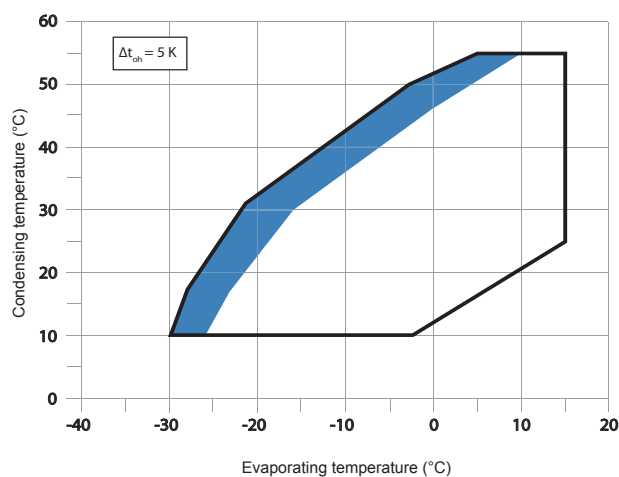

- Additional cooling
- Suction gas superheat > 10K
- Water cooled head mandatory
- t_{oh} Suction gas temperature (°C)
- Δt_{oh} Suction superheating (K)

Technical data

Compressor	Displacement (m ³ /h)		Weight kg	Connections				Speed rpm
	1450 rpm	1750 rpm		Suction		Discharge		
				Ø mm	inches	Ø mm	inches	
C6-146Y	146	175	190	67	2 ⁵ / ₈	42	1 ⁷ / ₈	700 <-> 1800
C6-162Y	162	194	190	67	2 ⁵ / ₈	42	1 ⁷ / ₈	
C6-188Y	188	226	190	67	2 ⁵ / ₈	42	1 ⁷ / ₈	
C6-146A	146	175	190	67	2 ⁵ / ₈	42	1 ⁷ / ₈	
C6-162A	162	194	190	67	2 ⁵ / ₈	42	1 ⁷ / ₈	
C6-188A	188	226	190	67	2 ⁵ / ₈	42	1 ⁷ / ₈	

All models available starting from Q1 2015.

Dimensional drawings

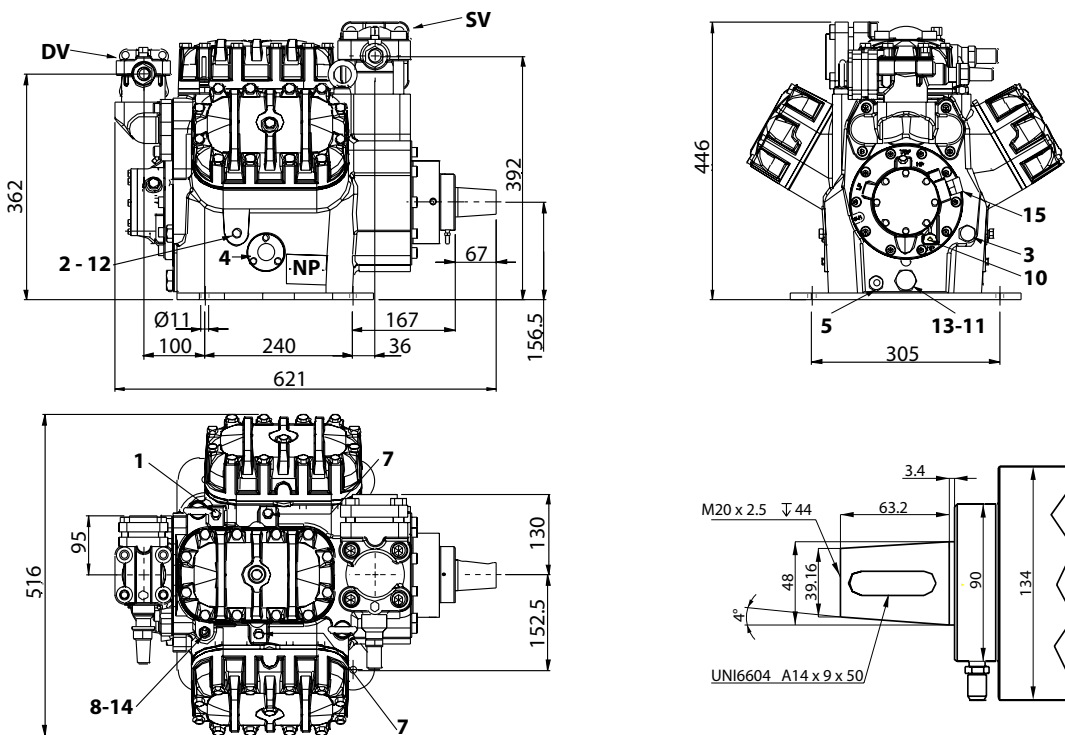

DRAWING NOTES

1	High pressure plug	1/8" NPT
2	Low pressure plug	1/4" NPT
3	Oil charge plug	3/8" GAS
4	Oil level sight glass	-
5	Crankcase heater seat	-
6	Oil drain plug	1/4" GAS
7	Liquid injection valve plug	1/8" NPT
8	Liquid injection sensor plug	-
9	Oil pressure switch connection (LP)	1/4" SAE

DRAWING NOTES

10	Oil pressure switch connection (HP)	1/4" SAE
11	Oil filter	3/8" GAS
12	Oil return plug	1/4" NPT
13	Magnetic plug	3/8" GAS
14	Max discharge temperature sensor	-
15	Electronic oil pressure switch connection	-
DV	Discharge valve	-
NP	Name plate	-
SV	Suction valve	-

FRASCOLD SpA

Via B. Melzi 105 - 20027 Rescaldina (MI) Italy

Tel. +39 0331 742201 - Fax +39 0331 576102

mail: frascold@frascold.it - web: www.frascold.it